

Revsible Polarity

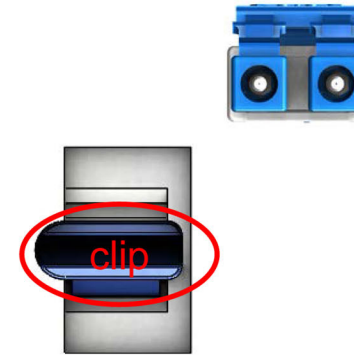

1

Apply pressure toward center of Trigger clip and inward (over and up).
 Trigger Clip will disengage from assembly

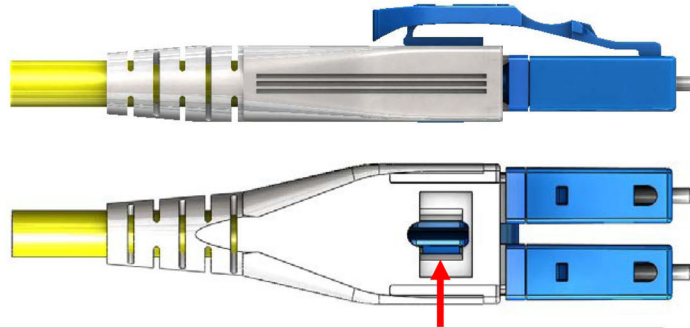
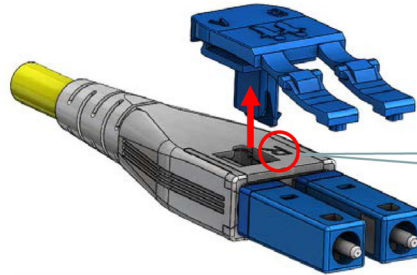

"R"
 On top of
 boot

2

Lift Trigger Clip up & off connector
 assembly

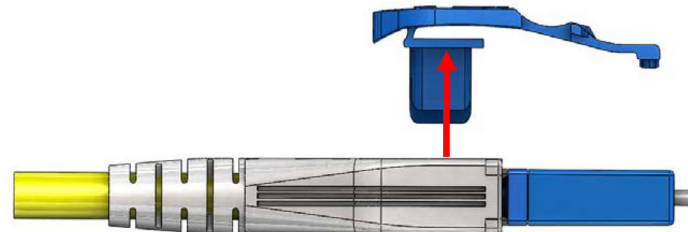
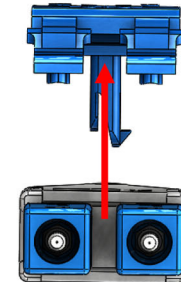

Patented

Reversible Polarity

- 3 Rotate connector assembly 180 degrees, ("R" on boot top center hole, is now on bottom)

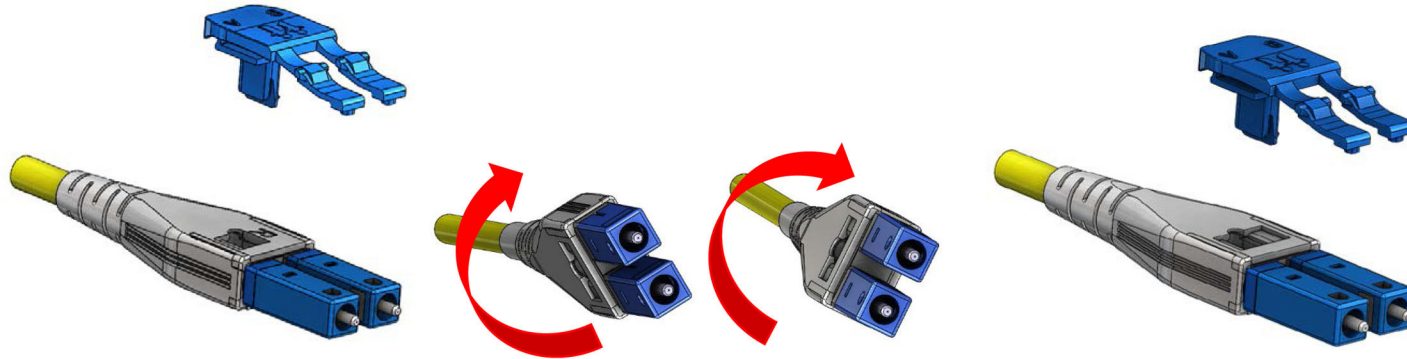

- 4 Press fit Trigger Clip firmly back into 180 degree reversed connector assembly

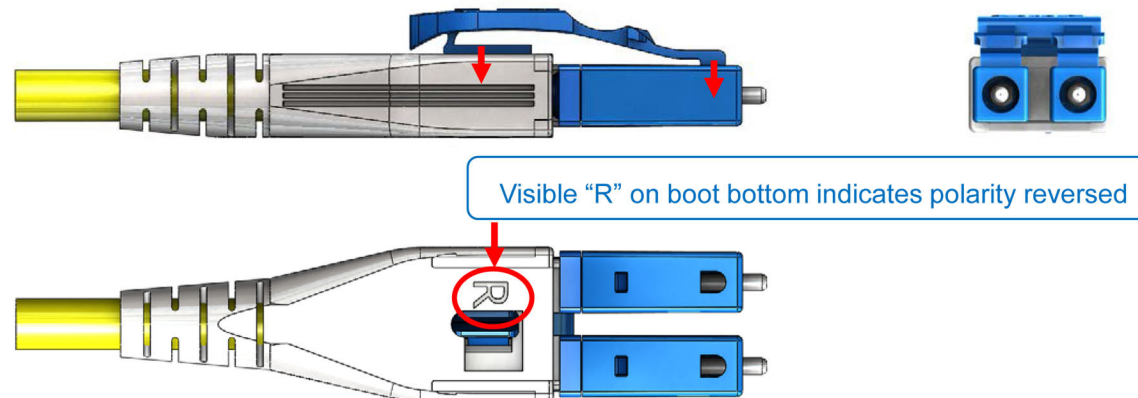

Patented